

ŁUKASZ WIECHETEK

ORCID ID: <https://orcid.org/0000-0001-7755-2282>

lukasz.wiechetek@umcs.pl

MAREK MĘDREK

ORCID ID: <https://orcid.org/0000-0001-5752-5084>

marek.medrek@umcs.pl

*Synergizing Logistics Processes and Process Management –
a Framework of BPM Course Based on Business Cases, BPM
Standards and Tools*

Synergia procesów logistycznych i zarządzania procesami – propozycja kursu z obszaru modelowania procesów biznesowych z wykorzystaniem przypadków biznesowych, standardów i narzędzi BPM

Keywords: BPM; business process modelling; BPM education; BPM knowledge; ADONIS; teaching framework; BPM syllabus; BPM curriculum

Słowa kluczowe: BPM; modelowanie procesów biznesowych; edukacja BPM; ADONIS; sylabus; program nauczania BPM; kurs BPM

JEL code: L86; M20; D83

1. Introduction

The origins of BPM as a cross discipline theory in practice are related to quality management and concepts of Total Quality Management (TQM), Six Sigma and ISO [Lusk et al., 2005, pp. 1–2]. This methodology was supported in the 1990s by such techniques as workflows, process automation, Enterprise Resource Planning

(ERP) and Service-Oriented Architecture (SOA). All these components started to merge to bring business processes more into the thinking of management, and the term “BPM” was coined [Jeston, Nelis, 2014].

BPM is now a systematic approach to making workflow in organization more effective and capable of adapting to an ever-changing environment [Gong, Janssen, 2012]. The main goal of BPM is to reduce human error and miscommunication and focus stakeholders on the requirements of their roles. From an organizational point of view, BPM is a subset of infrastructure management that covers the administrative area concerned with maintaining and optimizing equipment of an organization and its main operations [Zairi, 1997]. BPM is also an interface between the IT department in an organization and business level operations. It helps adapt technical innovations in the creation of added value for customers. Flexibility and ease of interpretation of BPM techniques allows shortening the path between process design and its translation into working software and makes BPM a very useful tool that integrates three levels within an organization: the Enterprise Level, the Process Level and the Implementation Level.

The term “BPM” is used in many different ways. Some managers use it to refer to a general approach to the management of process change, while others use it more narrowly to refer to the use of software techniques to control the runtime management of business processes [Harmon, 2017]. In our work, we focus more on the most popular BPM technology solutions for improving business performance and process automation rather than on methodology designed to organize, manage and measure the processes inside the organization.

There are several leading BPM standards in the market. Figure 1 presents the popularity of different standards of process management in organizations during the last several years. The most impressive pattern is the growing importance of the OMG’s¹ Business Process Model and Notation (BPMN), which continues to dominate the process standards space [Harmon, 2017]. Other techniques used for describing the processes (Figure 1) are Universal Modeling Language (UML), Business Process Execution Language (BPEL), ARIS software notation and some elements of the ISO 9000 management systems standard.

¹ Object Management Group: an international, open membership, not-for-profit technology standards consortium.

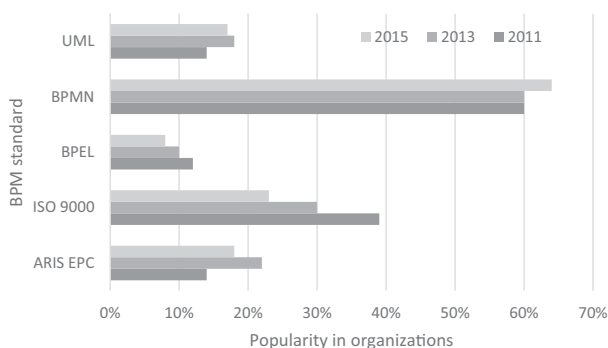

Figure 1. Popularity of BPM standards in organizations in 2011, 2013 and 2015

Source: Harmon [2017].

1.1. Business Process Model and Notations

Business Process Modelling Notation (BPMN) is a standardized notation for describing and modelling business processes. The first version of BPMN was developed by S. White in cooperation with the Business Process Management Initiative. Since 2006, BPMN has been an international standard of OMG. The current version of BPMN (2.0) was released in 2010, and the name of the standard was changed to Business Process Model and Notations (because of the introduction of the metamodel of the notation) [Weilkiens et al., 2016]. BPMN is an important industry standard for graphical process modelling [Zur et al., 2013, p. 429].

BPMN is designed with sufficient details to allow it to be the basis of an executable process description [Badura, 2014], and it allows for the mapping of a graphical notation in an executable XML-based process language (e.g. WSBPEL²). It allows visualizing a rich set of process flow semantics within a process and the communications between independent processes. BPMN supports three types of diagrams: the process diagram, that is, the operational sequence as a model, and the conversation and choreography diagrams that are used in special cases.

Figure 2 presents the most popular types of software tools used in organizations by process practitioners. To describe or document business processes, some organizations use simple graphics tools like Visio that do not allow creating a database or repository that can save and accumulate information about business processes. Simulation and modelling tools are designed mainly to define and document business processes and to store some information about the processes. The most complete and most used solution is the BPM suite, which incorporates all these features.

² Web Service Business Process Execution Language: standard executable language for specifying actions within business processes with web services.

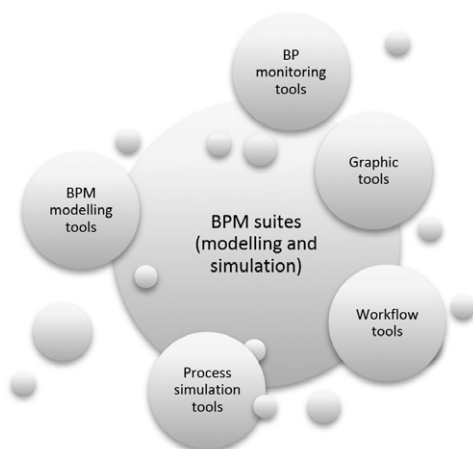

Figure 2. Major types of software tools used by process practitioners

Source: Harmon [2017].

In our teaching framework, we provide students with a software suite that allows for modelling, analysing, and simulation of processes. The framework is presented in section 2.

1.2. Business processes modelling education in logistics

Logistics area set of business procedures and business partners that manage the flow of goods and information from the point of design to the delivery of the products or services to the end consumer. From another point of view, logistics consists of coordinated flows of activities and resources with the goal of providing value to a customer. Such definitions fit also the business process description, so logistics is one of the best areas in the context of process management and automation.

Figure 3 presents the main advantages of using BPM in logistics. Process management can help organizations increase productivity, improve compliance and transparency, and increase the ability to respond to market changes. Process automation can also lead to saving time and eliminate the chance of human errors, which is another important factor in using BPM. However, the most important factor in modelling processes in logistics is the ability to broadly monitor the processes that result from the use of workflow systems.

Our goal is therefore to show students the entire lifecycle of a business process, from modelling, through implementing, executing, monitoring, and optimization. A more detailed description of the classes' configuration and schedule is included in the second section of the article.

BPM is an important element of both information systems and management education, and BPM courses are conducted in many high schools. However, BPM teaching standards are not sufficiently developed [Bandara et al., 2007, p. 1132].

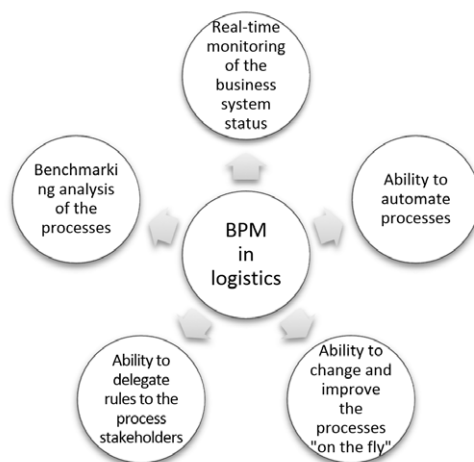

Figure 3. Main advantages of using BPM in logistics

Source: Authors' own work.

Delavari et al. [2010] presented a critical review based on content analysis of BPM education in Australia. They noticed the lack of BPM skilled professionals, and, therefore, they mapped courses offered by Australian universities to identify the gaps between BPM course contents and BPM capabilities. The authors also observed not enough commercial trainings and large demand for external consultant support in BPM projects. Seethamraju also analysed the current state in the area of business education. He concludes that BPM is frequently a subject of formal study, but the processes are still not fully understood by the students. Business schools teach primary function-specific skills, and IT schools concentrate on technical aspects of processes [Seethamraju, 2012, p. 532]. Indulska et al. investigated perceived benefits of BPM. They present the benefits of BPM for three groups of BPM stakeholders: practitioners, academics, and vendors. They conclude that BPM benefits vary mostly between practitioners and academics, so business process courses should be prepared based on the needs of different groups of students [Indulska et al., 2009, p. 458]. For practitioners the benefits of BPM can be both efficiency, effectiveness and the agility [Rudden, 2007, pp. 3–4]. Rosemann and vom Brocke suggest that BPM consists of six core elements: strategic alignment, governance, methods, information technology, people, and culture [Rosemann, vom Brocke, 2015, p. 105]. All these areas should be the topics of BPM courses. Based on an analysis of an international virtual seminar, Bergener et al. stress the importance of agile communication in BPM education [Bergener et al., 2012, p. 415]. In the literature, we can find many sample curricula. The sample BPM syllabus is presented by Bandara et al. [2007, p. 1132]. This framework can be deployed by schools and universities that are willing to create their own BPM curricula [Bandara et al., 2007, p. 1132]. Experiences, challenges, and recommendations in the area of teaching business

process modelling are presented also by Recker and Rosemann [2009], Bandara et al. [2010], and Antonucci [2010].

In the next sections of our paper, we present a BPM course framework for students of logistics prepared in accordance with good practices and recommendations that we have identified.

2. BPM course description

Our teaching framework provides students with the opportunity to use BPM suites software in complex environments and practice the techniques of modelling and analysing processes in real software tools. We use Problem-based Learning as an instructional approach that encourages creative thinking about real life problems with open-ended solutions [Mędrak, Tatarczak, 2017].

Business process modelling at the Faculty of Economics (Maria Curie-Skłodowska University) is the subject of master's degree studies and takes place within the scope of business intelligence. The schedule includes 45 hours of lectures and 45 hours of laboratory during two semesters for full-time students and 27 hours of lectures and 27 hours of labs for part-time students. At earlier stages of their studies, students do not have the opportunity to deal with any process modelling software environments, so we start with the basic level. Configuration of the BPM laboratory is described in section 2.1, and the organization and major topics are presented in section 2.2.

2.1. Configuration of the BPM laboratory

The presented solution includes selected and verified software components available under flexible licenses (Bonita, Camunda). We want to teach our students

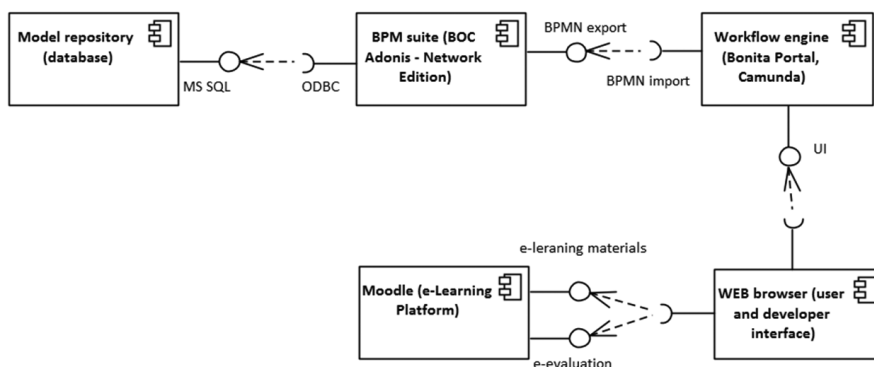

Figure 4. Components diagram of BPM laboratory

Source: Authors' own work.

solutions that can be supported by commercial vendors and are used in real business systems. We use the commercial ADONIS suite [Karagiannis, Kuhn, 2002], provided via a non-profit academic contract with the BOC Group. The e-learning platform is based on the Moodle system, which provides an assessment and communication kits essential in the teaching process. The system implements a single sign-on technique for all subsystems and central console for a user, model management, and controlling the education process. The database-based repository of models provides access to student materials from any campus computer and gives the ability for collaboration and evaluation of analysed models. Figure 4 shows the major components of BPM lab.

2.2. Organization of the BPM laboratory

The BPM course provides students with a comprehensive view of the business process life cycle. The classes include information on the process of discovering, modelling, implementing, and executing. Figure 5 presents the course agenda with learning objectives. Generally, the course is divided into four parts that lead the student from the basic level of process visualization, through mid-level process modelling to the final stage – practical use of processes in workflow environment.

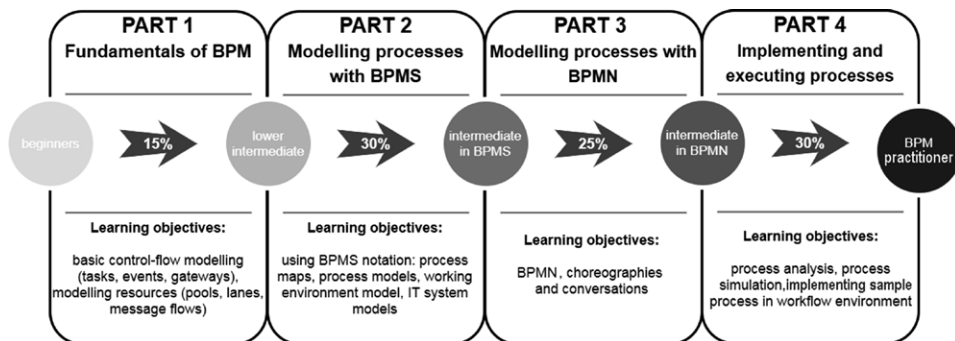

Figure 5. The BPM course parts and objectives

Source: Authors' own work.

After each part of the course, students in small groups (three persons) prepare models for the sample project scenario using the ADONIS suite. The models are verified and analysed with the tools provided by ADONIS. Some models are used for simulation and estimation of costs and the time of the chosen path of the processes. At the final stage of the course, students implement a sample process exported from the modelling environment (in XML format) in an on-line workflow platform (Bonita or Camunda). Developed projects are mainly related to transportation, education, trade, infrastructure management, and e-commerce.

3. Gaining knowledge and skills in BPM – students' opinions

To collect students' opinions about BPM and the BPM course, the authors prepared a questionnaire that contained 25 short open and closed questions that addressed knowledge of the BPM term, sources of knowledge about BPM, BPM areas of usage, benefits from using BPM, and preferable BPM tools. Teachers asked also about what the most useful skills were that were acquired during the course and barriers that emerged during the BPM laboratory. The online questionnaire was prepared in LimeSurvey and completed by students after the last course meeting in June 2017.

3.1. Research questions

The research and observation were performed to get answers to the following questions:

- Did students know the term “business process modelling” before attending the BPM classes?
- How do students understand the BPM term?
- What are the main sources of knowledge about BPM?
- What are the main ways of learning about BPM?
- What are the students' opinions about the main areas of BPM usage?
- What BPM applications do students know?
- What features should have good BPM application?
- What skills were acquired during the BPM course?
- What kind of problems emerged while students were attending classes on BPM?

3.2. The characteristics of the respondents

The BPM course was attended by 116 students, all of whom were asked to fill out the questionnaire. The BPM survey was filled out by 38 respondents (36 full-time students and two part-time students). Table 2 presents the characteristic of the surveyed students.

Table 2. The characteristic of the surveyed students

Characteristic		Number	(%)
Gender	woman	13	34
	man	25	66
Age	21	3	8
	22	7	18
	23	18	47
	24	7	18
	25	3	8

Characteristic		Number	(%)
Type of study	part-time	2	5
	full-time	36	95
Status	employed	18	53
	not employed	20	47
Interest in IT technology	definitely no	1	3
	rather no	4	11
	no opinion	15	39
	rather yes	16	42
	definitely yes	2	5

Source: Authors' own work.

Among the respondents aged from 21 to 25 years, 66% were men and 34% were women. Most of the respondents were full-time students (95%). More than half were employed (53%). Almost half of the respondents showed strong or moderate interest in IT technology (5% and 42%, respectively), while only 14% stated that they are not interested in IT.

3.3. Data analysis

Students' knowledge about BPM

The respondents stated that before attending the BPM classes, they lacked or had very little knowledge about BPM (Figure 6).

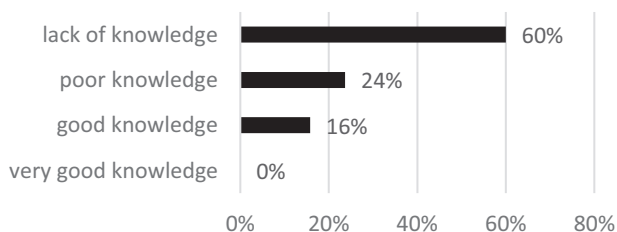

Figure 6. Knowledge about BPM

Source: Authors' own work.

Most of the respondents indicated a complete lack of (61%) or poor knowledge (24%) about process modelling before attending the course. Only 16% answered that their knowledge about BPM at the beginning of the classes was good. None of the respondents had very good knowledge about BPM.

Sources of knowledge about BPM

In the first part of the survey, the authors asked students about sources of knowledge about BPM. In this question, the respondents could choose more than one answer from the closed list of eight categories. Most of the respondents indicated university courses (95%) and Internet sources (24%) (Figure 7).

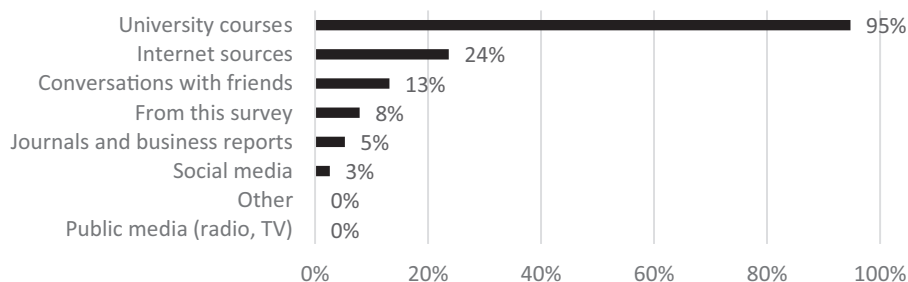

Figure 7. Source of knowledge about BPM

Source: Authors' own work.

Ways of gaining knowledge and skills in BPM

Young people can use different methods to gain knowledge and skills. To indicate how they had acquired knowledge in the area of BPM, the respondents could indicate one or more answers from the closed list (Figure 8).

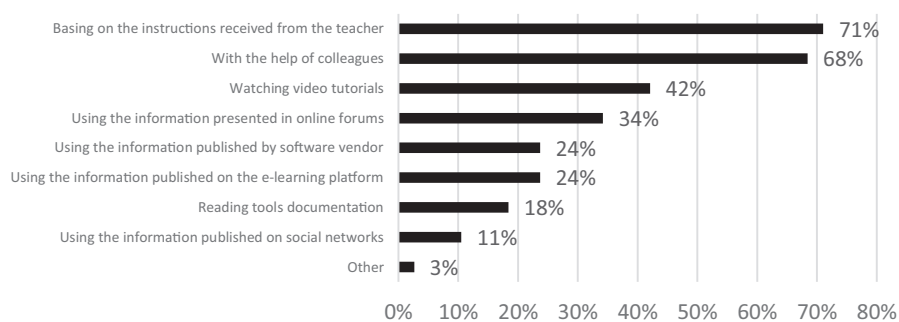

Figure 8. Ways of acquiring knowledge about BPM

Source: Authors' own work.

Majority of the respondents used instructions from the teacher (71%) and asked colleagues for help (68%). Fewer students identified video tutorials and Internet forums (42% and 34%, respectively). The least popular ways of learning were reading

the BPM tool documentation and using information published on social networks. An additional 3% of the respondents asked their parents for help (other).

Terms associated with BPM

In one of the first questions, students were asked to write one sentence about what in their opinion is the best characteristic of business process modelling. Analysis of the answers shows that BPM was mostly associated with:

- activities performed by business analysts,
- better process organization,
- controlling the processes,
- creating algorithms and testing them,
- developing diagrams of selected processes in the company,
- graphical representation of processes,
- industrial, logistic and production processes,
- model creation,
- modelling everything one can think of,
- process design,
- process optimization,
- simplifying the process, and
- tasks ordering.

We can say that answers given by students can be assembled into a broad definition of a set of BPM tasks performed by analysts to identify how the organization operates, present it in graphical form, and perform some simulations and, finally, optimizations.

The main areas of using BPM

After finishing the BPM course, when the students had gained some knowledge and skills in BPM, they were asked about their opinions about areas of BPM usage. Respondents could choose one or more answers from the closed list, including implementation of the quality system, optimizing resource utilization, estimation of resource demand, process control, process cost control, control of task execution time, company reorganization, control of competences and responsibilities, and, finally, other.

Respondents expressed that they would like to use BPM techniques and tools mostly for cost control, process control, and optimizing resources utilization (66% and more) (Figure 9).

Less frequently indicated areas were implementation of quality systems, estimation of resource demand, and control of competences (39%, 37% and 29%, respectively). Students were also asked if they would like to use BPM solutions (standards, methods, and tools) in their future work (Figure 10).

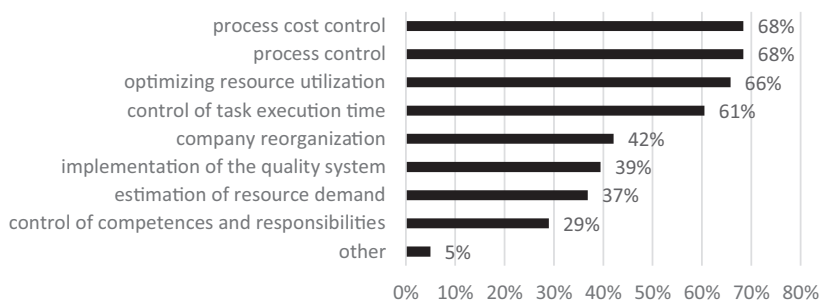

Figure 9. Main areas of BPM usage

Source: Authors' own work.

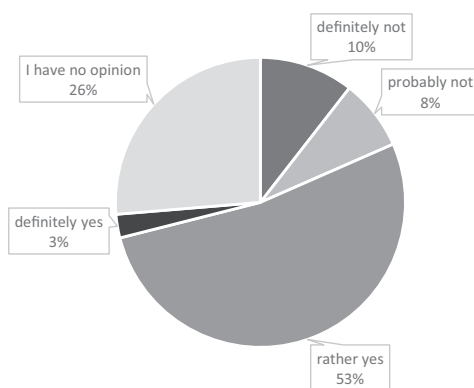

Figure 10. Willingness to use BPM solutions in future work

Source: Authors' own work.

The majority of respondents would like to use BPM solutions in their future work (3% “definitely yes”, 53% “rather yes”). Only 18% of students who participated in the study were not interested in using BPM at work.

Applications used for process modelling

The researchers were also interested in whether the students know the names of the tools for process modelling. At the end of the lecture and laboratories course, attendees were asked to provide three names of BPM tools. Almost all the respondents mentioned ADONIS, the BPM tool that was used during the classes. A small group indicated also MATLAB and Simulink. There were no other programme names.

Each respondent was also asked to indicate three advantages of ADONIS, the BPM tool used during laboratories. After finishing the BPM course, attendees said that in their opinion, the most desired attributes of used application were ease of use, clarity, functionality, and simplicity (Figure 11).



Figure 11. Important attributes of ADONIS

Source: Authors' own work with [wordclouds].

Course attendees stressed mostly ease of use (18 times), clarity (18 times), functionality (10 times), simplicity (9 times), and speed of work (7 times). Less frequently mentioned (less than 4 times) were the possibility of performing simulations, availability, Polish language version, and intuitive interface.

The main problems that emerged during project development

To identify main problems that occurred during the BPM lab, at the end of the questionnaire, respondents were asked to write up to three problems (three short texts). Students' opinions were analysed and grouped into categories related to the used tool, basic knowledge, course organization, speed of course, and time. Some attendees indicated also some technical barriers and difficulties in cooperation with the teacher (Figure 12).

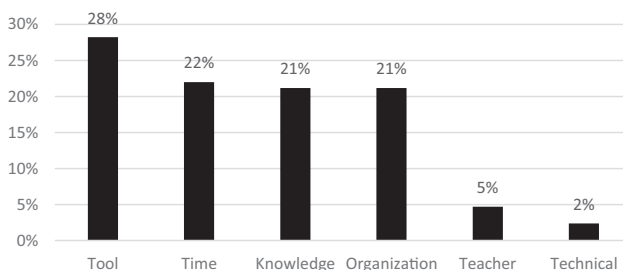

Figure 12. Categories of problems occurred during BPM labs

Source: Authors' own work.

The most frequently indicated problems were related to tool usage and functionality (28%), time (22%), lack of basic knowledge, and organizational problems (both 21%). Table 3 shows the detailed problems students reported.

Table 3. The main problems indicated by students

Category	Problem	Category	Problem	
Tool	difficult programme	Knowledge	learning of new working environment	
	determining the costs of processes		no previous experience in BPM tools	
	difficulties in making model modifications		no experience in process modelling	
	hanging programme		using the programme for the first time	
	numerous programme errors		lack of basic knowledge	
	Time	programme usage	Course organization	a lot of materials
		running the simulation		absenteeism
		searching for errors		difficult tasks
		too complex forms		late hour
		too many parameters		level of material complexity
Time		too fast course		lots of data to process
		lack of time for taking accurate notes		no air conditioning in the lab
	lack of time to assimilate the material	no free access to the database		
	no time to create complex models	no Polish language version at home		
	time-consuming models	perfect precision required		
	too fast pace of activities	Teacher	some instructions not fully clear	
too little time	complexity of processes			
Knowledge	difficult tasks		complexity of some activities	
	lack of basic knowledge		too little explanations	
	lack of knowledge at the beginning		Technical	no possibility to use models at home
	logical process organization	hardware failures		
	new area of knowledge	problems with university computers		

Source: Authors' own work.

In the area of tool performance and functionality, students indicated that the application was too difficult for them. It had too many options, some of them were hard to find and use, and sometimes the application was unstable. Attendants had also a lot of problems with time and course speed. Many of them stated that labs were performed too quickly and there was no time for taking notes and designing such complex models. In the category of knowledge, the respondents indicated mostly lack of basic knowledge, the need to learn a new environment, and no previous experiences in BPM tools.

Lessons learned during the project

At the end of the survey, the respondents were asked about new knowledge and skills that they had acquired during the BPM classes. Each respondent could write up to three short sentences (describing three gained competences). Analysis of the answers shows that students acquired new competences mainly in the following categories:

- data and time analysis,
- using the ADONIS tool,
- group work,

- performing simulations,
- creating diagrams and process maps,
- searching for data in the Internet, and
- patience and coping with stress.

Conclusions

The research performed at the end of BPM course and the authors' observations during the course show that young people were keen on business process modelling. They would like to use BPM methods and tools in their future education or work (56%). The analysis allows us to draw several conclusions.

- At the beginning of the BPM laboratories, students had no knowledge of BPM and a lot of concerns. They had difficulties in understanding the process structure and using the ADONIS tool. To overcome these problems, the teacher showed how to model simple known processes like admission to study, e-commerce (on-line shopping) or transport order in the ADONIS suite. Due to the students' lack of basic knowledge in the area of BPM, the authors suggest including some elements of BPM at the beginning of business bachelor studies, for example, in information technology or basics of management classes.
- Students acquired knowledge about BPM mainly based on instructions received from the teacher and asking colleagues for help. The least popular sources were tool documentation and posts published on Internet forums. We note that the examined young people (members of Z generation) are not interested in reading text documents – they prefer watching and group work. Therefore, the materials for course attendees should be interactive, preferably in the form of video tutorials.
- After finishing the course, students were able to indicate many areas of BPM usage like process control, optimizing resource utilization, cost and execution time control, and they noticed the great potential of using BPM methods and tools in an organization.
- Unfortunately, after 30 hours of BPM instruction, it was difficult for students to identify the names of BPM programs other than ADONIS. Therefore, the authors propose introducing characteristics of different applications supporting process modelling. It is also worth conducting laboratories using more than one tool to stress similarities and differences between the applications.
- The laboratory activities confirmed that students like to work in small groups and they are able and willing to share knowledge. The main initial problem was lack of basic knowledge in the area of process modelling and no experience in working with BPM tools.
- The main problems related to the BPM tool were too many options, difficult usage, and sometimes the application was unstable. Students indicated also

some problems with time and course speed. For some of them, there was too little time for understanding and modelling such as complex processes, and some activities were also performed too fast. Therefore, the future version of BPM classes should contain fewer examples, and each case should be presented more slowly and discussed more thoroughly.

- Pilot implementation of BPM classes showed that course preparation did not require extra expenses on software and hardware. The authors used a free academic ADONIS license DBMS tool and open e-learning system. Medium-class computers and network connections were sufficient to use client-server architecture. Some money was spent only on organization of certified training for teachers.

Research limitations and future research

Process modelling can be used for identification, documentation, analysis, and improving processes in many organizations in industry, business, and administration. To implement BPM into an organization, managers need well-trained staff members who know not only processes but also modelling methods and modern BPM tools. That is why new business process modelling courses, especially for business students, should be prepared and evaluated. The presented research was limited only to students of logistics at MCSU. Therefore, future research could be performed to compare the results with different high schools from different countries. In the next step, the authors are going to compare differences in BPM knowledge and skills between students and young workers and check whether perception of process modelling depends on the level of basic IT competences.

References

- Antonucci, Y.L., *Business process management curriculum*, [in:] *Handbook on Business Process Management*, Springer, Berlin–Heidelberg 2010, pp. 423–442.
- Badura, D., *Modelling business processes in logistics with the use of diagrams BPMN and UML*, “Forum Scientiae Oeconomia” 2014, Vol. 2, pp. 35–50.
- Bandara, W., Chand, D.R., Chircu, A.M., Hintringer, S., Karagiannis, D., Recker, J.C., Van Rensburg, A., Usoff, C., Welke, R.J., *Business process management education in academia: Status, challenges, and recommendations*, “Communications of the Association for Information Systems” 2010, Vol. 27, pp. 743–776.
- Bandara, W., Rosemann, M., Davies, I.G., Tan, C., *A structured approach to determining appropriate content for emerging information systems subjects: An example for BPM curricula design*, “Proceedings of 18th Australasian Conference on Information Systems” 2007, pp. 1132–1141.
- Bergener, K., vom Brocke, J., Hofmann, S., Stein, A., vom Brocke, C., *On the importance of agile communication skills in BPM education: Design principles for international seminars*, “Knowledge Management & E-Learning” 2012, Vol. 4(4), pp. 415–434.

- Delavari, H., Bandara, W., Marjanovic, O., Mathiesen, P., *Business process management (BPM) education in Australia: A critical review based on content analysis*. "ACIS 2010 Proceedings" 2010.
- Gong, Y., Janssen, M., *From policy implementation to business process management: Principles for creating flexibility and agility*, "Government Information Quarterly" 2012, Vol. 29, pp. S61–S71.
- Harmon, P., *The state of Business Process Management 2016*, "BPTrends" 2017, <https://www.bptrends.com/bpt/wp-content/uploads/2015-BPT-Survey-Report.pdf> [access: 15.10.2017].
- Indulska, M., Green, P., Recker, J., Rosemann, M., *Business process modeling: Perceived benefits*, "International Conference on Conceptual Modeling", Springer, Berlin–Heidelberg 2009, pp. 458–471.
- Jeston, J., Nelis, J., *Business Process Management – Practical Guidelines for Successful Implementations*, Routledge, New York 2014.
- Karagiannis, D., Kuhn, H., *Metamodelling platforms – invited paper*, [in:] K. Bauknecht; A. Min Tjoa, G. Quirchmayer (eds.), *Proceedings of the 3rd International Conference*, Springer Verlag, Berlin–Heidelberg 2002.
- Lusk, S., Paley, S., Spanyi, A., *The evolution of business process management as a professional discipline*, "BPTrends" 2005, Vol. 20, pp. 1–9.
- Mędrek, M., Tatarczak, A., *Business Intelligence and Data Analysis in an Adaptive Web-Based Integrated Learning Environment*, "INTED 2017, 11th Annual International Technology, Education and Development Conference", Valencia 2017.
- Recker, J., Rosemann, M., *Teaching business process modelling: experiences and recommendations*, "Communications of the Association for Information Systems" 2009, Vol. 25(32), pp. 379–394.
- Rosemann, M., vom Brocke, J., *The six core elements of business process management*, [in:] *Handbook on Business Process Management*, Springer, Berlin–Heidelberg 2015, pp. 105–122.
- Rudden, J., *Making the Case for BPM: A Benefits Checklist*, "BPTrends" 2007, <http://www.bptrends.com/publicationfiles/01-07-ART-MakingtheCaseforBPM-BenefitsChecklist-Rudden.pdf> [access: 15.10.2017].
- Seethamraju, R., *Business process management: A missing link in business education*, "Business Process Management Journal" 2012, Vol. 18(3), pp. 532–547.
- Weilkiens, T., Weiss, C., Grass, A., Duggen, K.N., *OCEB 2 Certification Guide*, Elsevier 2016.
- Wordclouds, Online wordcloud generator, <https://www.wordclouds.com/> [access: 15.10.2017].
- Zairi, M., *Business process management: A boundaryless approach to modern competitiveness*, "Business Process Management" 1997, Vol. 3(1), pp. 64–80.
- Zur Muehlen, M., Recker, J., *How much language is enough? Theoretical and practical use of the business process modeling notation*, [in:] *Seminal Contributions to Information Systems Engineering*, Springer, Berlin–Heidelberg 2013, pp. 429–443.

Synergia procesów logistycznych i zarządzania procesami – propozycja kursu z obszaru modelowania procesów biznesowych z wykorzystaniem przypadków biznesowych, standardów i narzędzi BPM

Lepsza organizacja procesów powoduje niższe koszty funkcjonowania i wyższe dochody oraz wpływa pozytywnie na pracowników i postrzeganie organizacji przez klientów. Firmy logistyczne, działające na bardzo konkurencyjnych rynkach, nieustannie poszukują możliwości zapewnienia niezawodności procesów przy jednoczesnej poprawie ich efektywności. Ze względu na rosnącą złożoność procesów konieczne jest stosowanie systematycznego podejścia do projektowania, wdrażania, monitorowania i doskonalenia procesów w organizacji. Takie podejście może być realizowane za pomocą technik i narzędzi BPM (*Business Process Management*). Inwestycja w oprogramowanie BPM, w połączeniu z nowymi podejściami do realizacji projektu, umożliwi firmom wprowadzenie zrównoważonego programu optymalizacji procesów biznesowych. Wdrożenie BPM nie jest jednak łatwe z uwagi na złożoność procesów i mnogość interakcji między nimi.

W pierwszej części artykułu zaproponowano pewne ramy nauczania, które mogą być wykorzystywane w procesie edukacji studentów kierunków biznesowych w celu zwiększenia ich wiedzy i praktycznych umiejętności z zakresu notacji modelowania procesów biznesowych (BPMN) i stosowania zarządzania procesami w obszarze logistyki. Zaprezentowana propozycja kursu opiera się na praktycznych przypadkach biznesowych i światowych standardach BPM. Zapewnia ona studentom możliwość korzystania z oprogramowania (pakietów BPM) w złożonych środowiskach oraz ćwiczenia technik modelowania i analizowania procesów. W drugiej części opracowania przedstawiono analizę opinii studentów (uczestników zajęć BPM) na temat zdobywania wiedzy i umiejętności w zakresie BPM. Badania wskazują, że studenci wykazują zainteresowanie zajęciami z zakresu modelowania procesów biznesowych zorganizowanymi w formie laboratoriów komputerowych oraz chcieliby wykorzystywać poznane metody i narzędzia BPM w kolejnych etapach edukacji lub w przyszłej pracy zawodowej.

Synergizing Logistics Processes and Process Management – a Framework of BPM Course Based on Business Cases, BPM Standards and Tools

Better processes produce lower costs, higher revenues, motivated employees, and happier customers. Logistics companies operating in very competitive markets are continuously seeking opportunities to ensure process reliability while improving their productivity. Due to increasing process complexity, it is necessary to apply a systematic approach to designing, implementation, monitoring, and improvement of processes in the organization. Such an approach may be realized through Business Process Management (BPM) techniques and tools. An investment in BPM software, coupled with new approaches to project implementation, enables companies to introduce a sustainable business process improvement program. However, the implementation of BPM is not easy because of process complexity and multiplication of interactions specific for each organization.

In this paper, we propose some teaching frameworks that can be used during the education process to enhance practical skills in business process modeling notation (BPMN) and in the application of process management in the field of logistics. Our solution is based on practical cases and BPM worldwide standards. It provides students with the opportunity to use the BPM suites software in complex environments and practice the techniques of modelling and analysing processes. The presented framework may address many requirements of learning environments for business process analysts. In the second part of the article, we present the analysis of students' (attendees of BPM classes) opinions about gaining knowledge and skills in BPM. The research indicates that young people were keen on business process modelling classes organized in the form of problem-based laboratories and they would like to use the learned BPM methods and tools in their future education or work.